

Goulottes aluminium

Généralités et accessoires.....	37
GOCD 80-54.....	38
GOCD 100-54.....	40
GOCD 130-54.....	42
GOCD 160-54.....	44
GOCD 160-54 3C.....	46
GOCD 190-54 3C.....	48
GECD 82-77.....	50

Goulotte aluminium

à clipage direct

La gamme GOCD

Technique

Clipage direct sans accessoire temps de montage réduit.

Ces goulottes sont constituées d'un socle et, selon les modèles, d'un ou plusieurs couvercles encastrables par simple pression. Les ouvertures du socle sont étudiées pour le clipage direct des équipements 45 x 45.

Cloisonnement des compartiments

Le cloisonnement des compartiments est obtenu par une cloison de séparation PVC fixée sur rails en fond du socle.

Joint de sol

Sur les modèles de goulottes 130-54, 160-54, 190-54, la paroi inférieure du socle est rainurée pour recevoir un joint de sol.

Des dimensions personnalisées

Une large gamme de profilés 1, 2 ou 3 couvercles répond à vos besoins de câblage. Les socles de longueur standard (2 mètres) peuvent être fabriqués, sur demande, en longueurs spéciales.

Jonction rapide

La jonction de deux tronçons de goulotte est réalisée par éclisses métalliques.

Ce principe garantit une jonction rapide et obligatoirement de niveau. Le verrouillage est obtenu par vis de compression, à chaque extrémité de la pièce de jonction.

Ce principe garantit la continuité de la masse.

Produits mixtes

Les couvercles de la série GOCDT plastique étant identiques, toutes les plinthes GOCD peuvent être fournies avec un couvercle technopolymère.

Fiabilité

Les techniques de fabrication garantissent :

- un maintien maximum des appareillages.
- une résistance élevée aux chocs .

Sécurité

Les profilés de la gamme GOCD sont réalisés en conformité avec la norme NF-C-15-100.



720052



740045



720451



720498



720399/SR



720499/SR



720378



720452



Référence	Description	Emb.	UN
720451	Cloison de séparation (Ht 35 mm)	1	ML
720401	Éclisse de jonction	12	UN
720378	Capot disjoncteur 112,5	10	UN
720387	Panier disjoncteur	10	UN
720399/SR	Liaison de masse pour couvercle aluminium simple agrafe	10	UN
720499/SR	Liaison de masse pour couvercle aluminium double agrafe	10	UN
720052	Couvercle Aluminium 45 mm		ML
740045	Couvercle PVC		ML
720452	Joint de sol	6	ML

GOCD 80-54

Goulotte aluminium à clipage direct

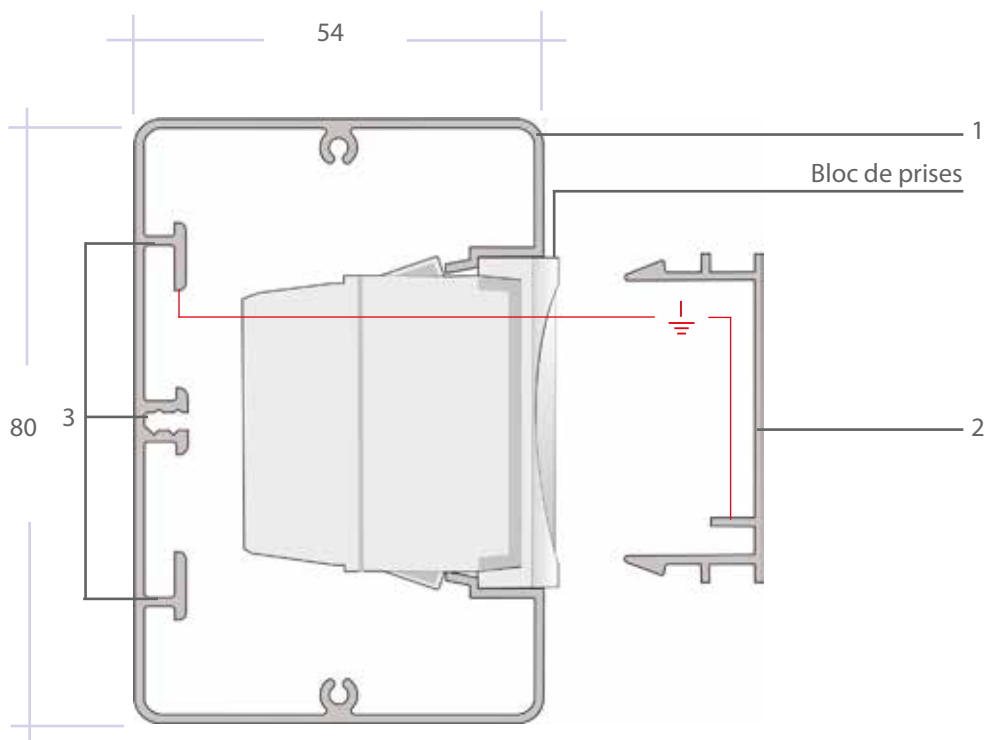

- 1- Socle
- 2- Couvercle
- 3- Rails de support de cloison

Echelle 1



Courant fort

	Réseau normal	Bloc de prises	Cond.	Réseau détrompé	
	PK4511/ 9010	1 prise Klé@	10 u	PK4521/ 3000	
	PK4512/ 9010	2 prises Klé@	10 u	PK4522/ 3000	
	PK4513/ 9010	3 prises Klé@	10 u	PK4523/ 3000	
	PK4514/ 9010	4 prises Klé@	10 u	PK4524/ 3000	

Courant faible

	Plastron simple + noyau	Plastron double + noyaux	
	UTP Cat6 réf: CF1041E6UTP	UTP Cat6 réf: CF1042E6UTP	
	FTP Cat6 réf: CF1041E6FTP	FTP Cat6 réf: CF1042E6FTP	



1 COUVERCLE

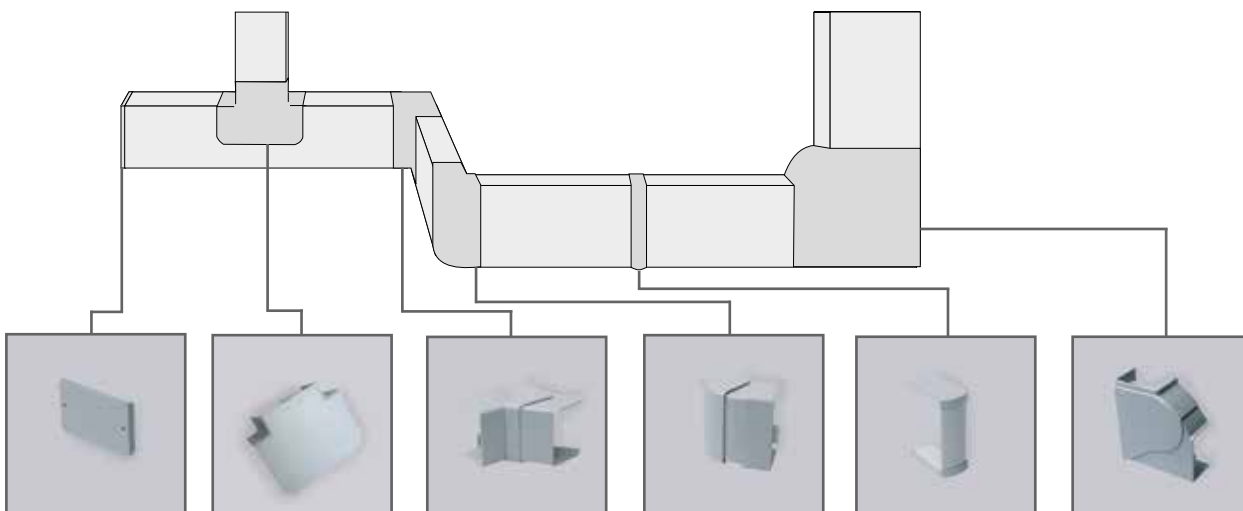

GOCD 80-54	Dimensions	Matière	Colisage	Clip45
Goulotte: socle + couvercle	Longueur 2 m	alu anodisé naturel		745025
Socle*	Longueur 3 m	alu anodisé naturel		745004
Couvercle technopolymère	Longueur 3 m	PVC		740045/7035
Couvercle alu	Longueur 3 m	alu anodisé naturel		720052
Liaison de masse simple agrafe	pour le socle		10 u	720399/SR
Liaison de masse double agrafe	pour couvercle alu		10 u	720499/SR
Embout de fermeture	pour le socle	ABS		720479/7035
Cloison de séparation		PVC		720451
Angle plat variable	LHT.142X152 mm		8 u	721470/7035
Jonction intérieure variable		ABS	5 u	721466/7035
Jonction extérieure variable		ABS	5 u	721469/7035
Angle de descente	Descente de 80x54	ABS	8 u	721574/7035
Angle de descente	Descente de 130x54	ABS	8 u	721575/7035
Cache jonction		PVC	10 u	740501/7035
Éclisse de jonction	2 par longueur	Acier galvanisé	20 u	720498

* Longueurs spéciales, nous consulter...

GOCD 100-54

Goulotte aluminium à clipage direct

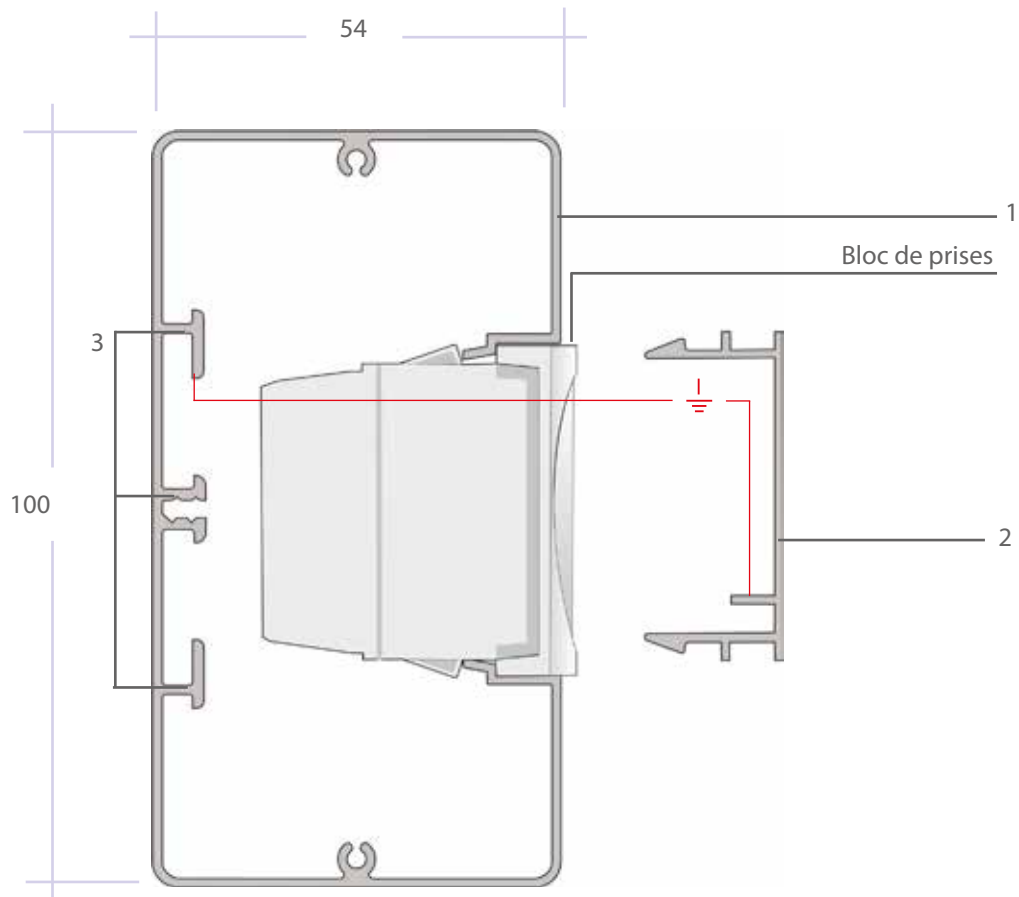

- 1- Socle
- 2- Couvercle
- 3- Rails de support de cloison

Echelle 1



Courant fort

	Réseau normal	Bloc de prises	Cond.	Réseau détrompé	
	PK4511/ 9010	1 prise Klé@	10 u	PK4521/ 3000	
	PK4512/ 9010	2 prises Klé@	10 u	PK4522/ 3000	
	PK4513/ 9010	3 prises Klé@	10 u	PK4523/ 3000	
	PK4514/ 9010	4 prises Klé@	10 u	PK4524/ 3000	

Courant faible

	Plastron simple + noyau	Plastron double + noyaux	
	UTP Cat6 réf: CF1041E6UTP	UTP Cat6 réf: CF1042E6UTP	
	FTP Cat6 réf: CF1041E6FTP	FTP Cat6 réf: CF1042E6FTP	



1 COUVERCLE

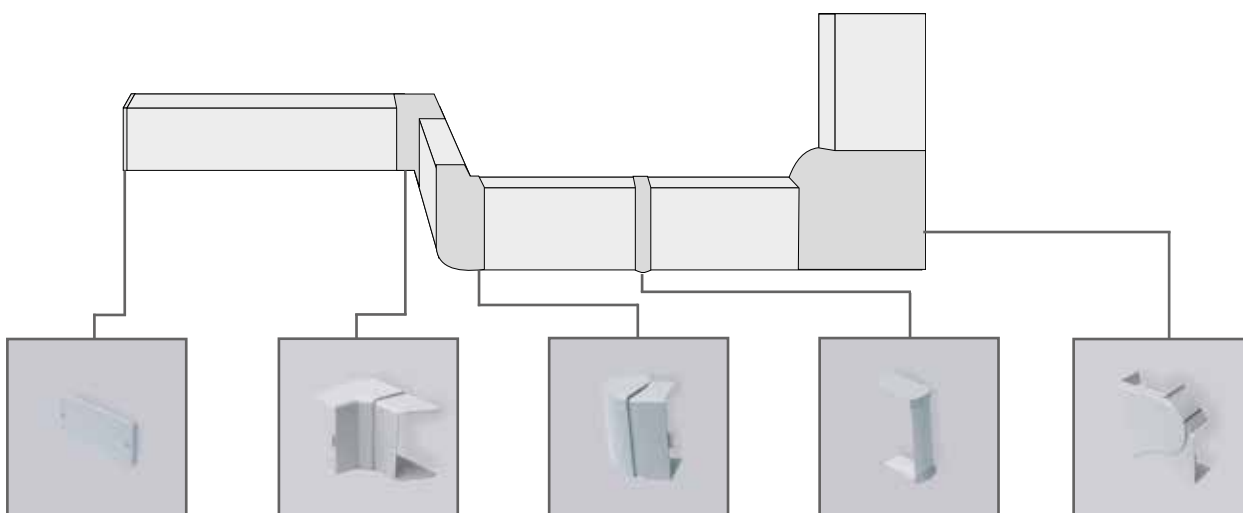

GOCD 100-54	Dimensions	Matière	Colisage	Clip.45
Goulotte: socle + couvercle	Longueur 2 m	alu anodisé naturel		745026
Socle*	Longueur 3 m	alu anodisé naturel		745005
Couvercle technopolymère	Longueur 3 m	PVC		740045/7035
Couvercle alu	Longueur 3 m	alu anodisé naturel		720052
Liaison de masse simple agrafe	pour le socle		10 u	720399/SR
Liaison de masse double agrafe	pour couvercle alu		10 u	720499/SR
Embout de fermeture		ABS		740449/7035
Cloison de séparation		PVC		720451
Angle plat variable	LHT.171X161 mm		6 u	721479/7035
Jonction intérieure variable		ABS	5 u	721476/7035
Jonction extérieure variable		ABS	5 u	721478/7035
Cache jonction		PVC	10 u	740502/7035
Éclisse de jonction	2 par longueur	Acier galvanisé	20 u	720498

* Longueurs spéciales, nous consulter...

GOCD 130-54

Goulotte aluminium à clipage direct

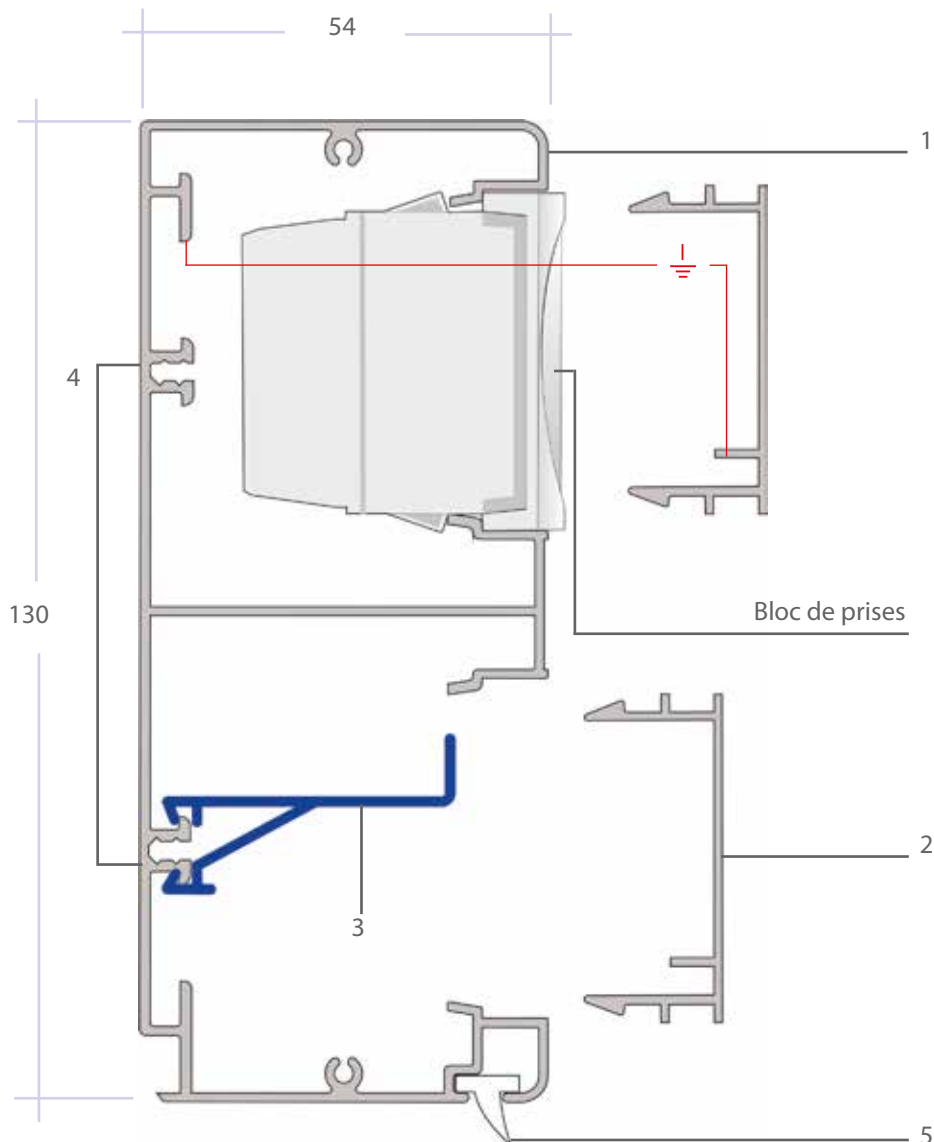

- 1- Socle
- 2- Couvercle
- 3- Cloison de séparation
- 4- Rails de support de cloison
- 5- Joint de sol

Echelle 1



Courant fort

	Réseau normal	Bloc de prises	Cond.	Réseau détrompé	
	PK4511/ 9010	1 prise Klé@	10 u	PK4521/ 3000	
	PK4512/ 9010	2 prises Klé@	10 u	PK4522/ 3000	
	PK4513/ 9010	3 prises Klé@	10 u	PK4523/ 3000	
	PK4514/ 9010	4 prises Klé@	10 u	PK4524/ 3000	

Courant faible

	Plastron simple + noyau	Plastron double + noyaux	
	UTP Cat6 réf: CF1041E6UTP	UTP Cat6 réf: CF1042E6UTP	
	FTP Cat6 réf: CF1041E6FTP	FTP Cat6 réf: CF1042E6FTP	



2 COUVERCLES

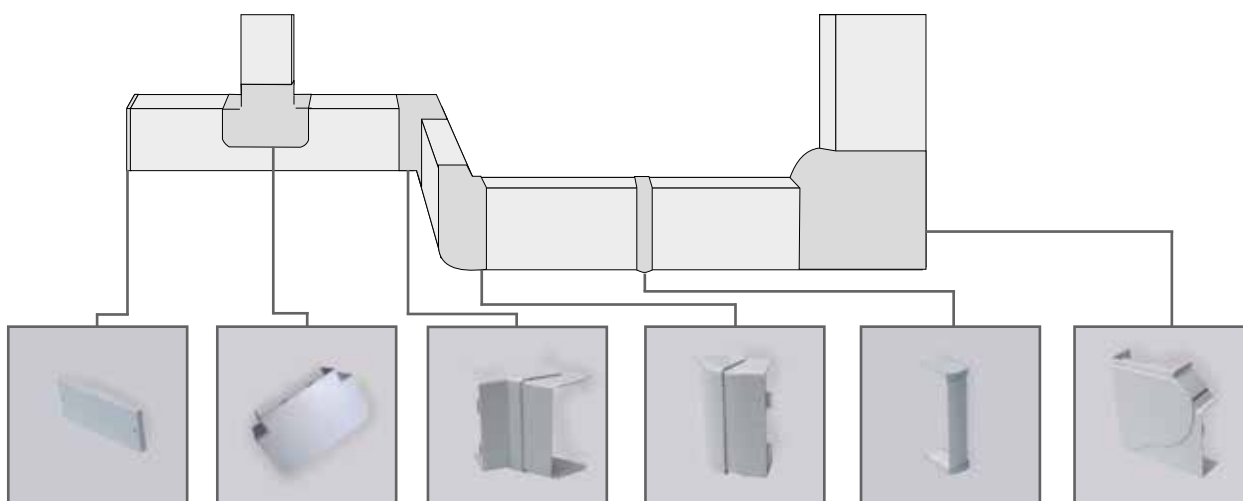

GOCD 130-54	Dimensions	Matière	Colisage	Clip.45
Goulotte: socle + couvercle	Longueur 2 m	alu anodisé naturel		745028
Socle*	Longueur 3 m	alu anodisé naturel		745002
Couvercle technopolymère	Longueur 3 m	PVC		740045/7035
Couvercle alu	Longueur 3 m	alu anodisé naturel		720052
Liaison de masse simple agrafe	pour le socle		10 u	720399/SR
Liaison de masse double agrafe	pour couvercle alu		10 u	720499/SR
Embout de fermeture		ABS		740479/7035
Cloison de séparation		PVC		720451
Angle plat variable	LHT.200X190 mm	ABS	4 u	721483/7035
Jonction intérieure variable		ABS	5 u	721481/7035
Jonction extérieure variable		ABS	5 u	721485/7035
Angle de descente	Descente de 80x54	ABS	8 u	721574/7035
Angle de descente	Descente de 130x54	ABS	8 u	721575/7035
Cache jonction		PVC	10 u	740503/7035
Éclisse de jonction	2 par longueur	Acier galvanisé	20 u	720498
Joint de sol	Longueur 2 m	PVC souple	6 m	720452

* Longueurs spéciales, nous consulter...

GOCD 160-54

Goulotte aluminium à clipage direct

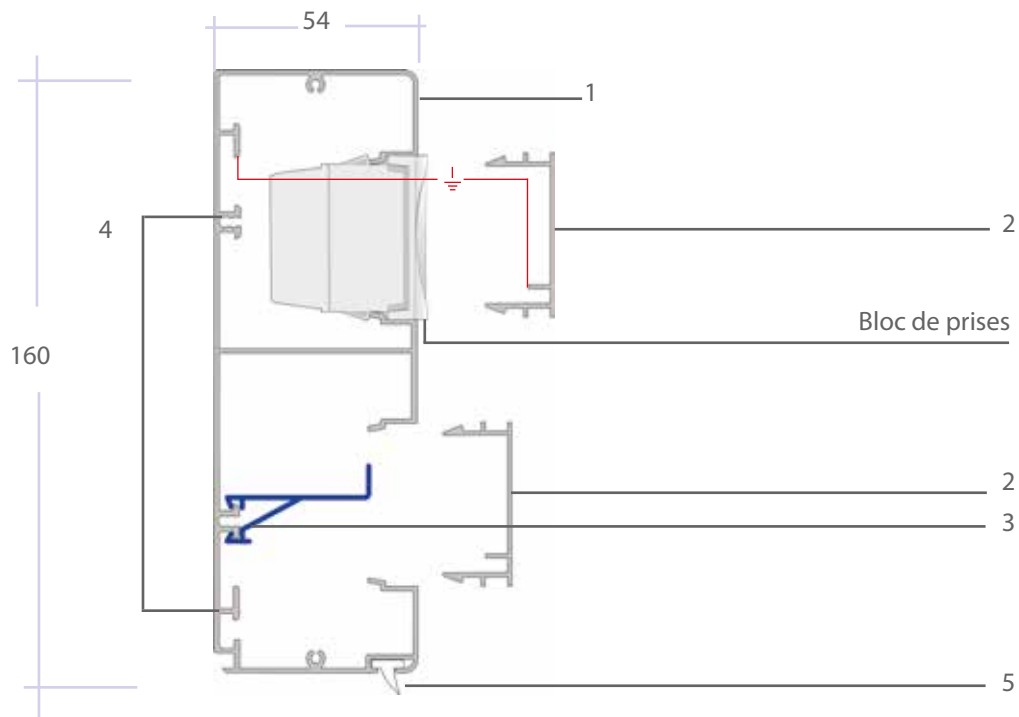

- 1- Socle
- 2- Couvercle
- 3- Cloison de séparation
- 4- Rails de support de cloison
- 5- Joint de sol





Echelle 1/2

Courant fort

	Réseau normal	Bloc de prises	Cond.	Réseau détrompé	
	PK4511/ 9010	1 prise Klé@	10 u	PK4521/ 3000	
	PK4512/ 9010	2 prises Klé@	10 u	PK4522/ 3000	
	PK4513/ 9010	3 prises Klé@	10 u	PK4523/ 3000	
	PK4514/ 9010	4 prises Klé@	10 u	PK4524/ 3000	

Courant faible

	Plastron simple + noyau	Plastron double + noyaux	
	UTP Cat6 réf: CF1041E6UTP	UTP Cat6 réf: CF1042E6UTP	
	FTP Cat6 réf: CF1041E6FTP	FTP Cat6 réf: CF1042E6FTP	



2 COUVERCLES

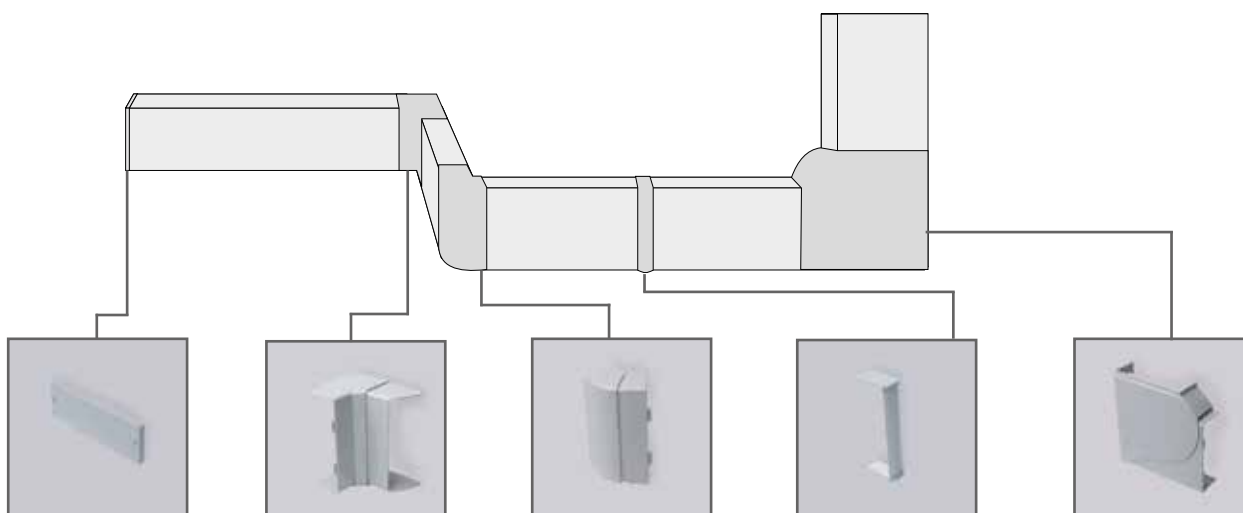

GOCD 160-54	Dimensions	Matière	Colisage	Clip.45
Goulotte: socle + couvercle	Longueur 2 m	alu anodisé naturel		745029
Socle*	Longueur 3 m	alu anodisé naturel		745001
Couvercle technopolymère	Longueur 3 m	PVC		740045/7035
Couvercle alu	Longueur 3 m	alu anodisé naturel		720052
Liaison de masse simple agrafe	pour le socle		10 u	720399/SR
Liaison de masse double agrafe	pour couvercle alu		10 u	720499/SR
Embout de fermeture		ABS		740409/7035
Cloison de séparation		PVC		720451
Angle plat variable	LHT.233X223 mm	ABS	4 u	721488/7035
Jonction intérieure variable		ABS	5 u	721482/7035
Jonction extérieure variable		ABS	5 u	721487/7035
Cache jonction		PVC	10 u	740504/7035
Éclisse de jonction	2 par longueur	Acier galvanisé	20 u	720498
Joint de sol	Longueur 2 m	PVC souple	6 m	720452

* Longueurs spéciales, nous consulter...

GOCD 160-54 3C

Goulotte aluminium à clipage direct

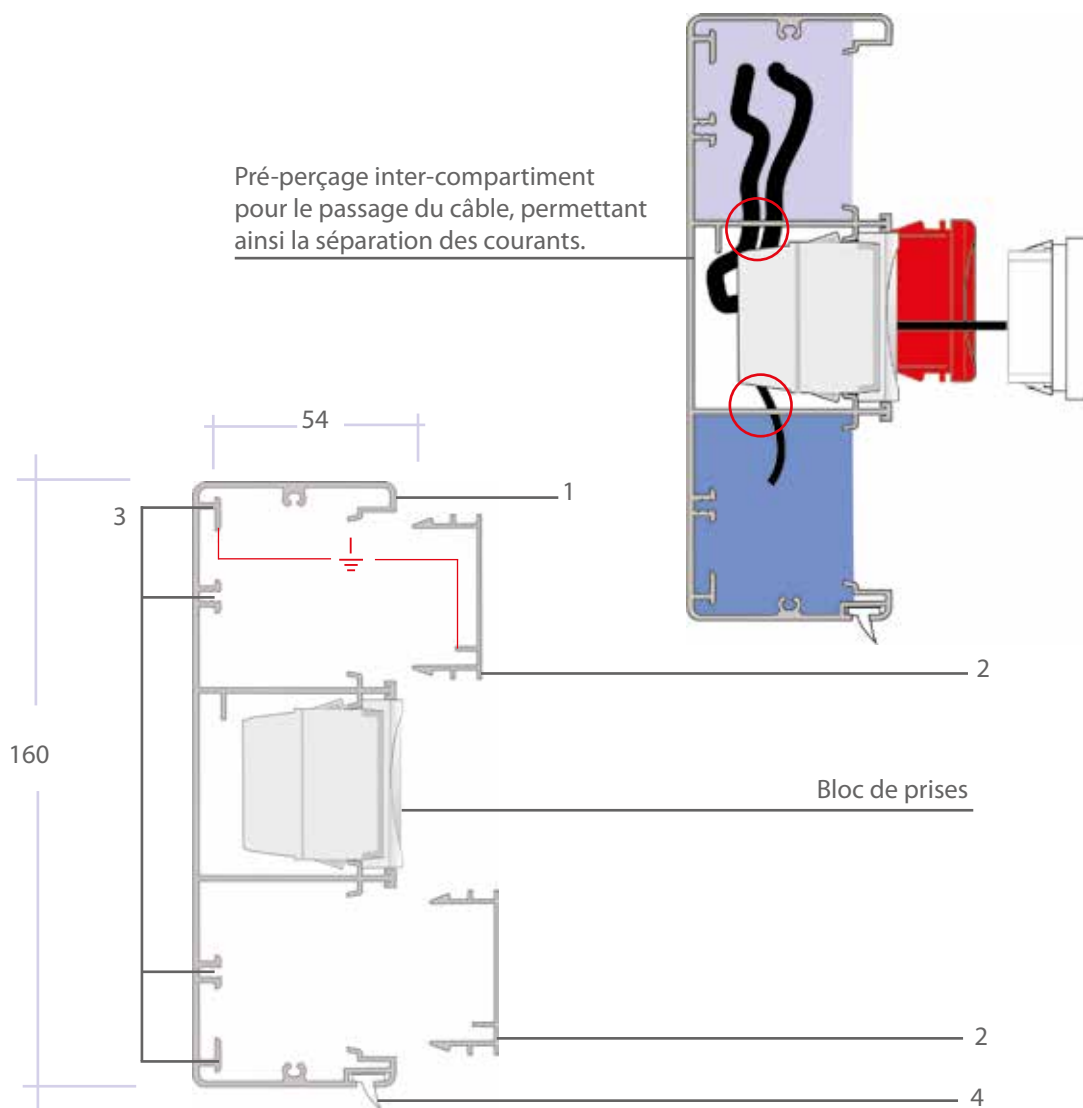

- 1- Socle
- 2- Couvertres
- 3- Rails de support de cloison
- 4- Joint de sol





Echelle 1/2

Courant fort

	Réseau normal	Bloc de prises	Cond.	Réseau détrompé	
	PK4511/ 9010	1 prise Klé@	10 u	PK4521/ 3000	
	PK4512/ 9010	2 prises Klé@	10 u	PK4522/ 3000	
	PK4513/ 9010	3 prises Klé@	10 u	PK4523/ 3000	
	PK4514/ 9010	4 prises Klé@	10 u	PK4524/ 3000	

Courant faible

	Plastron simple + noyau	Plastron double + noyaux	
	UTP Cat6 réf: CF1041E6UTP	UTP Cat6 réf: CF1042E6UTP	
	FTP Cat6 réf: CF1041E6FTP	FTP Cat6 réf: CF1042E6FTP	



3 COUVERCLES

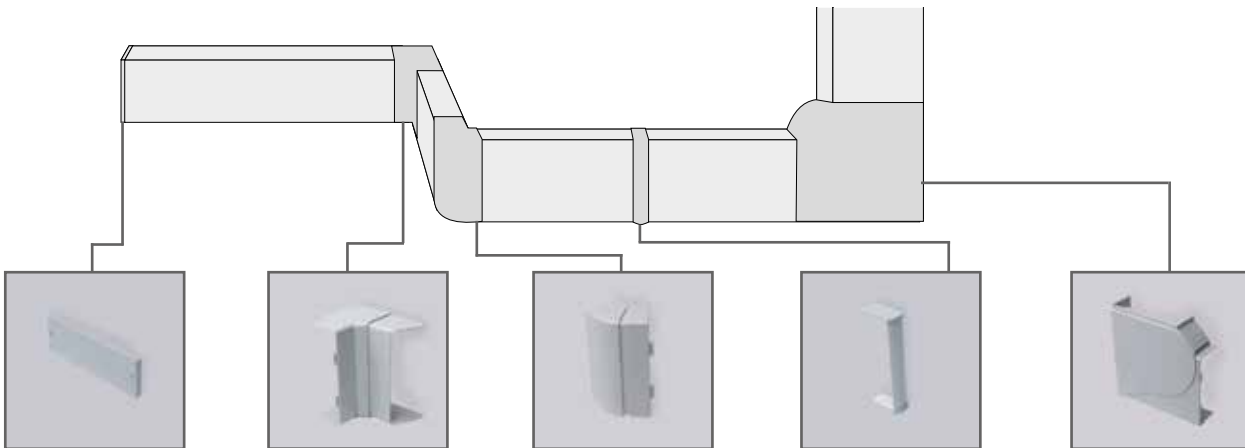

GOCD 160-54 3C	Dimensions	Matière	Colisage	Clip.45
Goulotte: socle + couvercle	Longueur 2 m	alu anodisé naturel		745039
Socle*	Longueur 3 m	alu anodisé naturel		745003
Couvercle technopolymère	Longueur 3 m	PVC		740045/7035
Couvercle alu	Longueur 3 m	alu anodisé naturel		720052
Liaison de masse simple agrafe	pour le socle		10 u	720399/SR
Liaison de masse double agrafe	pour couvercle alu		10 u	720499/SR
Embout de fermeture		ABS		740409/7035
Angle plat variable	LHT.233X223 mm	ABS	4 u	721488/7035
Jonction intérieure variable		ABS	5 u	721482/7035
Jonction extérieure variable		ABS	5 u	721487/7035
Cache jonction		PVC	10 u	740504/7035
Éclisse de jonction	2 par longueur	Acier galvanisé	20 u	720498
Joint de sol	Longueur 2 m	PVC souple	6 m	720452

* Longueurs spéciales, nous consulter...

GOCD 190-54 3C

Goulotte aluminium à clipage direct

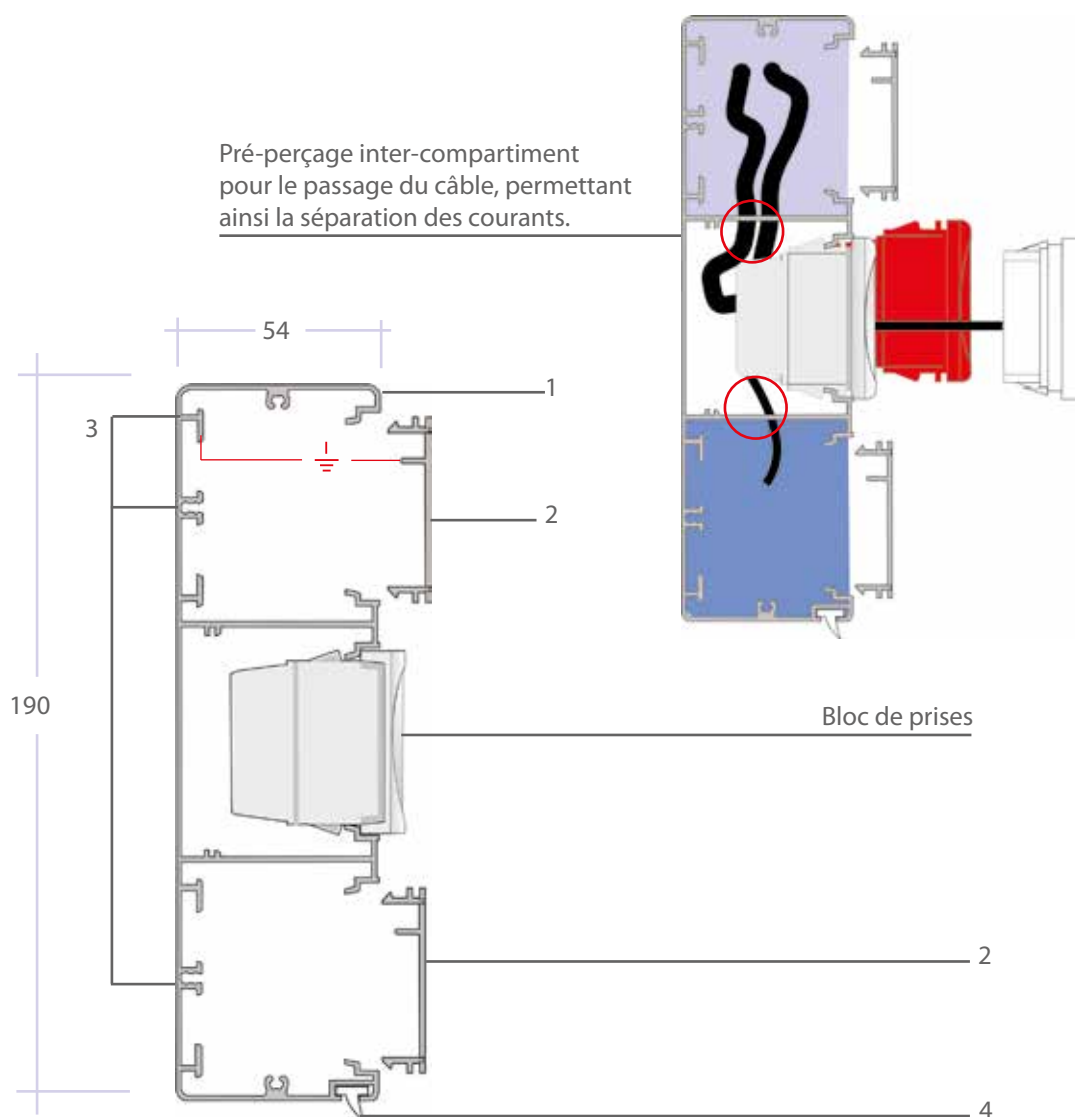

- 1- Socle
- 2- Couvertres
- 3- Rails de support de cloison
- 4- Joint de sol

Echelle 1/2



Courant fort

	Réseau normal	Bloc de prises	Cond.	Réseau détrompé	
	PK4511/ 9010	1 prise Klé@	10 u	PK4521/ 3000	
	PK4512/ 9010	2 prises Klé@	10 u	PK4522/ 3000	
	PK4513/ 9010	3 prises Klé@	10 u	PK4523/ 3000	
	PK4514/ 9010	4 prises Klé@	10 u	PK4524/ 3000	

Courant faible

	Plastron simple + noyau	Plastron double + noyaux	
	UTP Cat6 réf: CF1041E6UTP	UTP Cat6 réf: CF1042E6UTP	
	FTP Cat6 réf: CF1041E6FTP	FTP Cat6 réf: CF1042E6FTP	



3 COUVERCLES

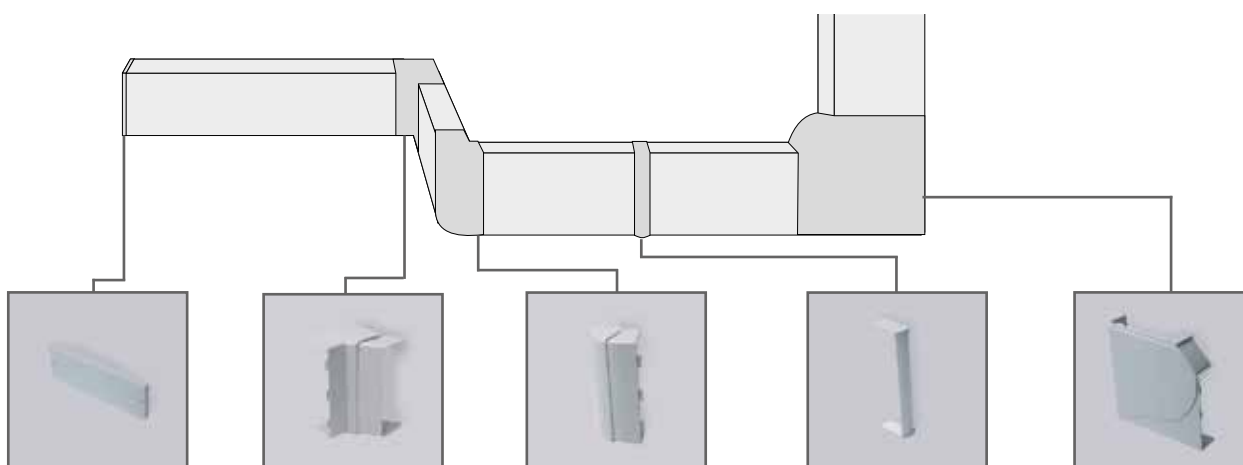

GOCD 190-54	Dimensions	Matière	Colisage	Clip.45
Goulotte: socle + couvercle	Longueur 2 m	alu anodisé naturel		745042
Socle*	Longueur 3 m	alu anodisé naturel		745015
Couvercle technopolymère	Longueur 3 m	PVC		740045/7035
Couvercle alu	Longueur 3 m	alu anodisé naturel		720052
Liaison de masse simple agrafe	pour le socle		10 u	720399/SR
Liaison de masse double agrafe	pour couvercle alu		10 u	720499/SR
Embout de fermeture		ABS		740430/7035
Angle plat variable	LHT.280X270 mm	ABS	6 u	721569/7035
Jonction intérieure variable		ABS	5 u	721566/7035
Jonction extérieure variable		ABS	5 u	721568/7035
Cache jonction		PVC	10 u	740809/7035
Éclisse de jonction	2 par longueur	Acier galvanisé	20 u	720498
Joint de sol	Longueur 2 m	PVC souple	6 m	720452

*Longueurs spéciales, nous consulter...